

Data Sheet



Article number: 021816011108

Description: Clamp with bracket and rubber
SPGU 6011. 108/30 SK

Measures

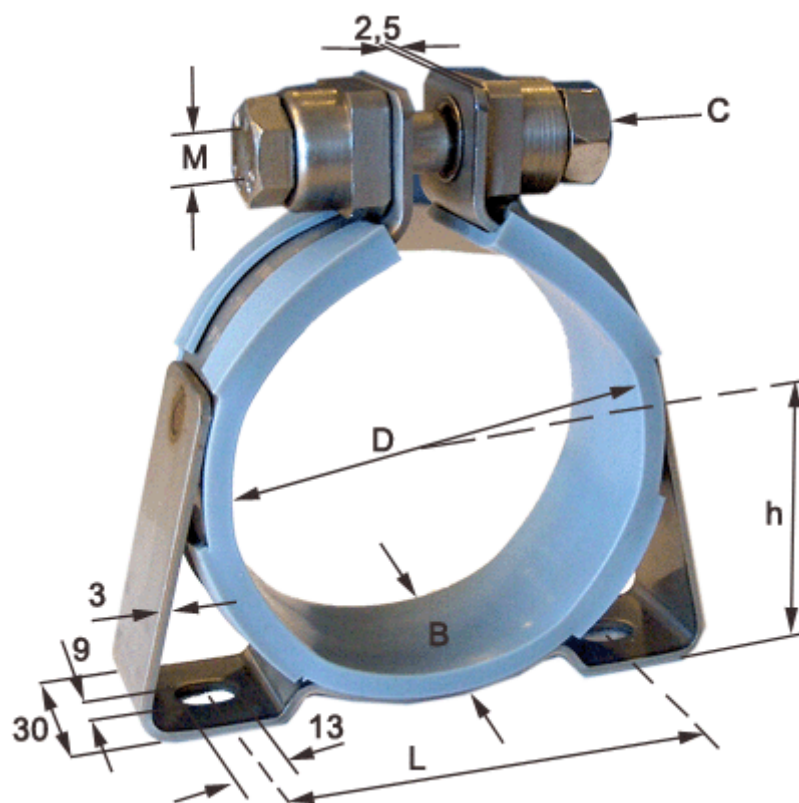

C (screw type) = SK hexagon screw

Diameter D = 108

h = 62

L = 100

Width B = 30